

**DAS LAGER**
GERMANY

WATER PUMPS & BEARINGS PRODUCT LIST

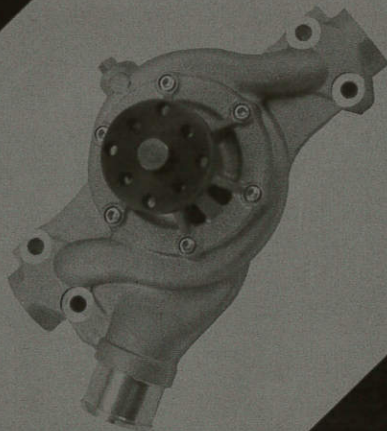
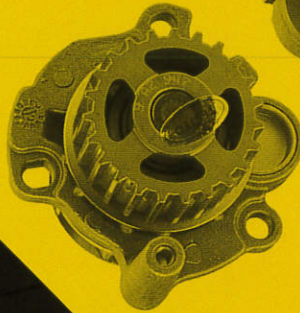
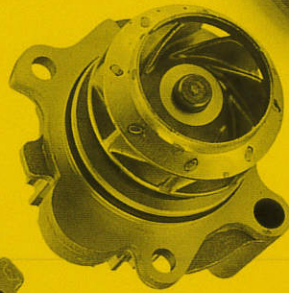
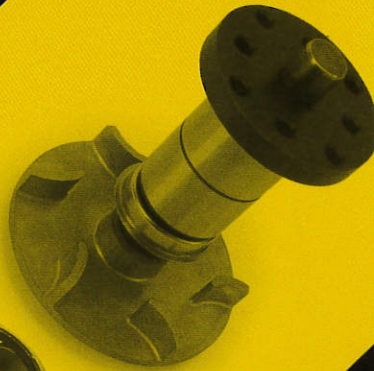

DAS LAGER GERMANY WATER PUMPS

Water pump is one of the most important parts of your car. The engine cooling system is designed to stabilise the temperature, limiting its rise within the set limits. The cooling fluid is circulated by the **water pump**, which must guarantee the correct flow at every engine rotation speed.

Failures in the system can cause significant damage to the engine. For this reason, it is extremely important that the *water pump* be systematically checked and replacing.





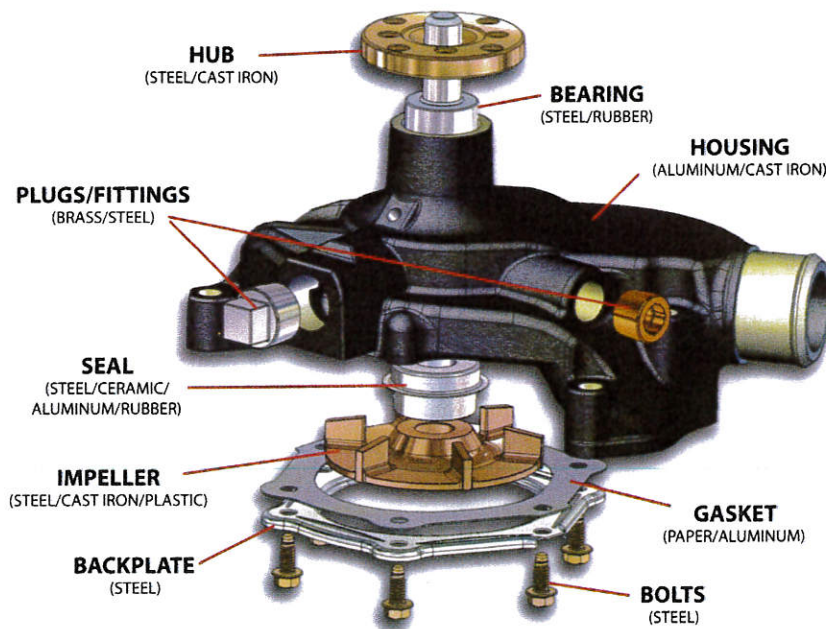



Das Lager Germany water pumps are reliable choice of repairing solution to avoid unplanned expensive mechanic losses.









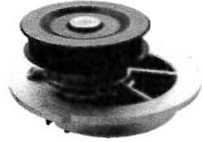

Generally water pumps have five basic components:















- The **housing** is the outer shell that encases the pump. It is typically made of cast iron or aluminum materials, although a number of modern engines use stamped-steel housings;
- The **impeller** spins and distributes coolant throughout the cooling system;
- The **bearing assembly** is the mechanical support that allows continuous rotation of the impeller;
- The **Hub** Attached to the bearing assembly is the hub, which is the connecting source of power for impeller rotation.
- The **seal** protects the bearing assembly from coolant and contaminates.

WATER PUMPS PRODUCT LIST

NO	DAS LAGER NO	BRAND	OEM NO	APPLICATION	YEAR	PRODUCT PHOTO
1	DLWP 603	DASLAGER	030121008D	AROSA 1.4	97	
				CORDOBA 1.4i-1.6-1.6i	93	
				IBIZA 1.4i-1.6-1.6i	93	
				INCA 1.4i-1.6i	95	
				FELICIA 1.6	94-99	
				GOLF III	95-97	
				POLO III	94-95	
				POLO CLASSIC	95	
				VENTO	95-97	
				CADDY	96-	
2	DLWP 674	DASLAGER	036121008L	A2 1.4 16V AUA/BBY	00-05	
				FABIA(6V2) 1.4 16V	99	
3	DLWP 1137	DASLAGER	03L121011J	VW JETTA	11-14	
4	DLWP 879	DASLAGER	045121011H	VW Caddy	04.-11	
				Fox	05.-12	
				Jetta	06.-11	
				Passat	06.-11	
				Polo	02.-10	
				Transporter	03.-10	
				Touran	03.10-	
				Sharan	03.-10	
				Skoda-Fabia	00.-10	
				Octavia	04-	
Roomster	06.-10					
Superb	8					
5	DLWP 904	DASLAGER	06B121011	A2 1.4 TDI	3	
				A3 1.6	96	
				A4 1.6-2.0	95	
				A6 1.8-2.0	97	
				TT 1.8T /ROADSTER	98	
				OCTAVIA 1.6	95	
					98	
				BORA/VARIANT 1.6L	97	
				GOLF /VARIANT 1.6L	99	
				NEW BEETLE 1.6L	97	
PASSAT/SANTANA						
6	DLWP 747	DASLAGER	1201.C4	PEUGEOT PARTNER DW8-DW10TD 1.9D/2.0HDI	99-09	
				jumpy 2.0	96-04	
7	DLWP 572	DASLAGER	1334053	LEGANZA 2.0 16V	02.-97	
				NUBIRA 2.0 16V	97	
				REZZO 2.0	01.	
				TACUMA 2.0	01.	
				VECTRA A 1.7 D-2.0i 16V	92-95	
				VECTRA B 1.8i-2.2i 16V	95-00	
ZAFIRA 2.0 Turbo-2.2 16V	99					
8	DLWP 577	DASLAGER	1334054	ASTRA F 1.6i-18i-2.0i	92-98	
				CALIBRA 2.0i	93-97	
				FRONTERA 2.0i	91	
				OMEGA A 2.0i	86-94	
				OMEGA B 2.0i	94	
				VECTRA A 1.8i-2.0i	92-96	
				VECTRA B 1.6i-2.0i	96	

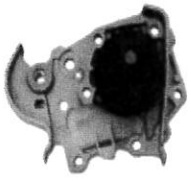
NO	DAS LAGER NO	BRAND	OEM NO	APPLICATION	YEAR	PRODUCT PHOTO
9	DLWP 442	DASLAGER	1334065	ASTRA F 1.4i-1.6i	91	
				ASTRA G 1.4i-1.6i	98	
				COMBO 1.2-1.4	01.-94	
				CORSA A 1.2-1.4-1.6	82-93	
				CORSA B 1.2-1.4	93-00	
				KADETT D 1.2i	79-84	
				DADETT E 1.2-1.4-1.6i	84-91	
				VECTRA A 1.4-1.6	88-95	
				VECTRA B 1.6i	95	
10	DLWP 541	DASLAGER	1334066	ASTRA G 1.4i-1.6i	92-98	
				ASTRA F 1.4i-1.6i	98	
				CORSA B 1.4i-1.6i 16V	93-00	
				CORSA C 1.4i 16V	0	
				TIGAR 1.4i-1.6i 16V	91-00	
				VECTRA B 1.6i 16V	95	
				ZAFIRA 1.6i 16V	99	
11	DLWP 572 A	DASLAGER	1334139	LEGANZA 2.0 16V	02.-97	
				NUBIRA 2.0 16V	97	
				REZZO 2.0	01.	
				TACUMA 2.0	01.	
12	DLWP 959	DASLAGER	1334142	AVEO		
				CRUZE		
				ASTRA G		
				ASTRA H		
				ASTRA J		
				INSIGNIA		
				MERIVA		
				MOKKA		
				VECTRA C		
13	DLWP 859	DASLAGER	256Q 8591 BA	FORD FIESTA 1.4 TDCI	02.-08	
				FUSIOAN 1.4 TDCI		
				CITROEN C1-C2-C3		
				PEUGEOT 206-207-208-307-1007-2008		
14	DLWP 286 A	DASLAGER	46423351	PANDA 0.75L, 1.0L		
				LANCIA FIRE 1.0L	03.-95	
				LANCI Y (840A) 1.1		
				Y10 1.0		
				Y10 1.1		
				PALIO		
				ALBEA		
				TIPO		
15	DLWP 286 A	DASLAGER	46515970	PANDA 1.1-1.2		
				ALBEA1.1-1.2		
				TIPO1.1-1.2		
				UNO1.1-1.2		
				Doblo1.9 JTD		
alfa romeo 147 1.9 8V JTD						
16	DLWP 866	DASLAGER	46520401	BRAVA 1.2 16V	01.-99	
				BRAVO 1.2 16V	01.-99	
				IDEA 1.4 16V	04.	
				MAREA 1.2 16V	03.-99	
				PUNTO 99 1.2 16V	99	
				PUNTO 99 1.4 16V	03.	
				500		
				LINEA1.4 16V		
17	DLWP 607	DASLAGER	504083122	JUMPER 2.5-2.8 HDI		
				DUCATO2.5-2.8 HDI		
				BOXER2.5-2.8 HDI		
18	DLWP 1083	DASLAGER	6334001	AVEO		
				ASTRA 1.3 CDTI		
				H-ASTRA 1.3 CDTI		
				J-CORSA 1.3 CDTI		
				CORSA D-1.3 CDTI		
19	DLWP 1019	DASLAGER	7438610006	LAGUNA 2.0i 16V RXT	01.-96	
				SAFRANE 2.0 i 16V RXT	96-00	
				FOCUS		
				KUGA		
				MONDEO		
				C30		
				C70		
				S40		
				S70		
				S80		

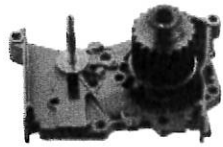
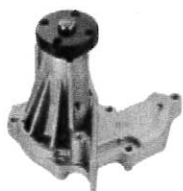
NO	DAS LAGER NO	BRAND	OEM NO	APPLICATION	YEAR	PRODUCT PHOTO
20	DLWP 412	DASLAGER	7700736091-7701633125	CLIO I 1.2.-1.4 R19 1.2.-1.4 R9 1.2-1.4		
21	DLWP 081	DASLAGER	7701457416	R12 1.3L R15 1.3L	70-80 69-72	
22	DLWP 550	DASLAGER	7701462145	RENAU 11 1.1 RENAU 11 1.4 CLIO I R9 1.2-1.4 R21	83-86 83-88	
23	DLWP 514	DASLAGER	7701465513	R21 CONCORDE TRAFIC-MASTER I		
24	DLWP 531	DASLAGER	7701473365	R5 SUPER R9 R11 R19 CHAMADE R21 CLIO CLIO ESPACE KANGOO	87-89 84-87 84-87 88-95 96-95 90-98 98 99 99	
25	DLWP 977	DASLAGER	7701475995	CLIO 1.5DCI (01-) CLIO III 1.5D-1.5DCI (05-) FLUENCE 1.5DCI (05-) GRAND SCENIC II 1.5DCI (04-) GRAND SCENIC III 1.5DCI (09-) KANGOO 1.5DCI (01-) LAGUNA III SPORTTOUR 1.5DCI (07-) LOGAN 1.5DCI (07-) MEGANE II 1.5DCI (02-) TWINGO 1.5DCI 90 (07-) MODUS 1.5DCI (04-) SCENIC II 1.5DCI (03-)		
26	DLWP 821	DASLAGER	7701476496	ALMERA NOTE MICRA- SCENIC II - MEGANE II- KANGOO CLIO II		
27	DLWP 599	DASLAGER	7784988	TEMPRA 1.4i /Spi TEMPRA 1.6i /Spi TIPO 1.4i /Spi TIPO 1.6i /Spi	92-96 90-97 88-93 88-96	

NO	DAS LAGER NO	BRAND	OEM NO	APPLICATION	YEAR	PRODUCT PHOTO
28	DLWP 1035	DASLAGER	8200146298-7700861686	LOGAN SENDERO CLIO II KANGOO MEGANE		
29	DLWP 633	DASLAGER	8200146301	CLIO II - MEGANE I KANGOO - R9 19 KANGOO EXPRESS		
30	DLWP 724 A	DASLAGER	8200582675-7700274330	MEGANE I LAGUNA KANGOO DUSTER CLIO III CLIO II LOGAN DUSTER		
31	DLWP 612	DASLAGER	96MX859 AA	FOCUS		
32	DLWP 8591	DASLAGER	YS6G 8591 AA	FOCUS FIESTA FUSION		

DAS LAGER GERMANY Water pump bearings

The water pump is the heart of the automotive cooling system. The pump circulates coolant throughout the system while the engine is running.

Das Lager Germany water pump bearing have special desing for application. There are double row and triple row types. It doesn't have inner ring. Due to it's improved design, it has integrated shaft insead of the inner ring. Bearing raceways are machined into the integrated shaft. This feature provides bigger rolling elements enabling higher load-carrying capability and because of compact design it can easily mounting.

Water pump bearing seals give protection against the ingress of contaminant and the egress of grease. Das Lager Germany seals are specifically designed for water pump applications. It provides superior grease retention for the life of the bearing and excellent contamination protection.

Lubrication

Water pump bearings are lubricated for life. Das Lager Germany carefully analyse application condition and selected grease for the longest bearing life.

As result of Das Lager Germany water pump bearings are lightweight, compact, good sealing performans and low friction. They offer high rotary speed, excellent heat resistance, high efficiency and reliability.

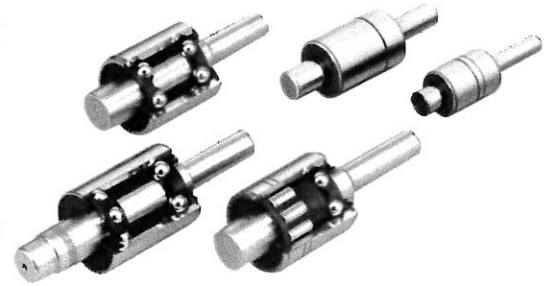

Das Lager Germany Water Pump Bearings

DAS LAGER GERMANY NO	OEM NO/BEARING NO	
DLWP 603	030121008D	PA603
DLWP 674	036121008L	PA674
DLWP 1137	03L121011J	PA 1137
DLWP 879	045121011H	PA879
DLWP 904	06B121011	PA904
DLWP 747	1201.C4	PA747
DLWP 572	1334053	PA572
DLWP 577	1334054	PA577
DLWP 442	1334065	PA442
DLWP 541	1334066	PA541
DLWP 572 A	1334139	PA572A
DLWP 959	1334142	PA959
DLWP 859	2S6Q 8591 BA	PA859
DLWP 286 A	46423351	PA286A
DLWP 672	46515970	PA672
DLWP 866	46520401	PA866
DLWP 607	504083122	PA607
DLWP 1083	6334001	PA1083
DLWP 1019	7438610006	PA1019
DLWP 412	7700736091-7701633125	PA412
DLWP 081	7701457416	PA081
DLWP 550	7701462145	PA550
DLWP 514	7701465513	PA514
DLWP 531	7701473365	PA531
DLWP 977	7701475995	PA977
DLWP 821	7701476496	PA821
DLWP 599	7784988	PA599
DLWP 1035	8200146298-7700861686	PA1035
DLWP 633	8200146301	PA633
DLWP 724 A	8200582675-7700274330	PA724A
DLWP 612	96MX859AA	PA612
DLWP 8591	YS6G 8591 AA	